

**RAILING  
UPGRADES**  
CUSTOM PRODUCT CATALOG  
2023-2024



**INTEX**<sup>®</sup>  
BY **AZEK**<sup>®</sup>

## Introducing INTEX Custom Solutions for TimberTech PVC Railing

*Made-to-order custom rail upgrades and accessories*

For the discerning customer who wants to go beyond the premium box-kit of TimberTech Cellular PVC railing, INTEX offers a variety of standard and custom upgrades for your railing infill, newel posts, and column wraps.

With premium infills ranging from Louver Design providing privacy with air-flow, or Decorative Panels creating beautiful curb appeal, INTEX offers a variety of ways to customize your premium Cellular PVC rail system. With Cellular PVC Column Wraps, Newel Wraps, and Railing by INTEX, we provide peace-of-mind that the highest standards for aesthetic, performance, and product life-cycle will be met.

Builders, contractors, and architects enjoy the peace of mind that comes with a manufacturer they can trust for support, from first inquiry through installation. INTEX will go above and beyond to ensure their partners and customers are satisfied with their products and service.

**Learn more at [intexbyazek.com](http://intexbyazek.com)**



### HOW TO ORDER PAGES:

A handy checklist with easy-to-follow steps to help guide you through the ordering process.



### PRICE KEY:

Shows lowest to highest price point.



### INSTALL KEY:

Shows range from DIY-friendly to craftsman level installation.

## TABLE OF CONTENTS

Radius Rail.....	3	Horizontal Balusters.....	11
Decorative Panels.....	4	Gates.....	12
Glass Balusters.....	8	Transition Kits.....	13
3-Line Rail & Mahogany.....	9	Column Wraps.....	14
Louver Infill.....	10	Newel Wraps.....	16

# Radius Rail RAIL UPGRADES

## Guaranteed Custom Radius Fit with Our Radius Rail Template Kit!



### CUSTOM IN-HOUSE RADIUS BENDS

We are proud to offer in-house Radius Rail arcs from 6ft, 8ft, and 10ft rail spans. For stairway applications 6ft and 8ft spans are available.

### THE INTEX GUARANTEE

We guarantee the Radius Rail fit when the INTEX Radius Rail Template Kit is used. Call 856-293-4100 to order a Radius Rail Template Kit!

### RADIUS RAIL AVAILABILITY

	Level Rail			Stair Rail	
	6'	8'	10'	6'	8'
TimberTech Statement Rail	✓	✓	✓	✓	✓
TimberTech Pinnacle Rail	✓	✓	✓	✓	✓



### RADIUS RAIL VIDEOS





Scan the QR code, then scroll to the "Rail Templating" section for Radius Rail tutorials!

# Decorative Panels RAIL UPGRADES

DECORATIVE PANEL COMMON FEATURES
All Deco Panel styles are available for all rail systems
All Deco Panel styles are available for level, stair & radius rails
All Deco Panel styles are available as 36" or 42" heights
TimberTech Statement Rail and TimberTech Pinnacle Rail Deco Panels come pre-finished and do not require paint, but can be painted with a Light Reflective Value (LRV) of 55 or greater

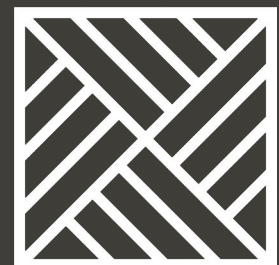

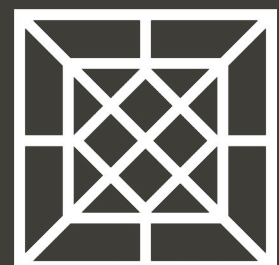
**Square Decorative Panel Standard Styles**

	
TYPE 2	AVALON
	
DIAMOND WEB	PRAIRIE

# Decorative Panels RAIL UPGRADES

The following page contains examples of fully-built rail sections featuring various Standard Deco Panels, Newel Wraps, Newel Caps, and Trim Rings. Please note all Deco Panels, Newel Wraps, Newel Caps, and Trim Rings are sold separately from Rail Kits.

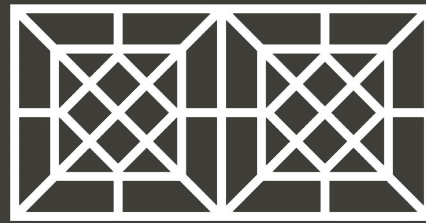
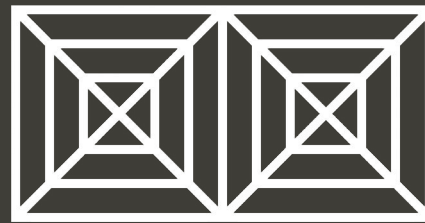
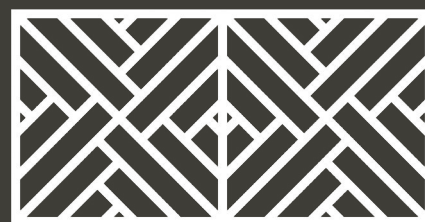

**Double Decorative Panel Standard Styles**

	
DOUBLE DIAMOND WEB	DOUBLE SQUARE WEB
	
DOUBLE TYPE 1	

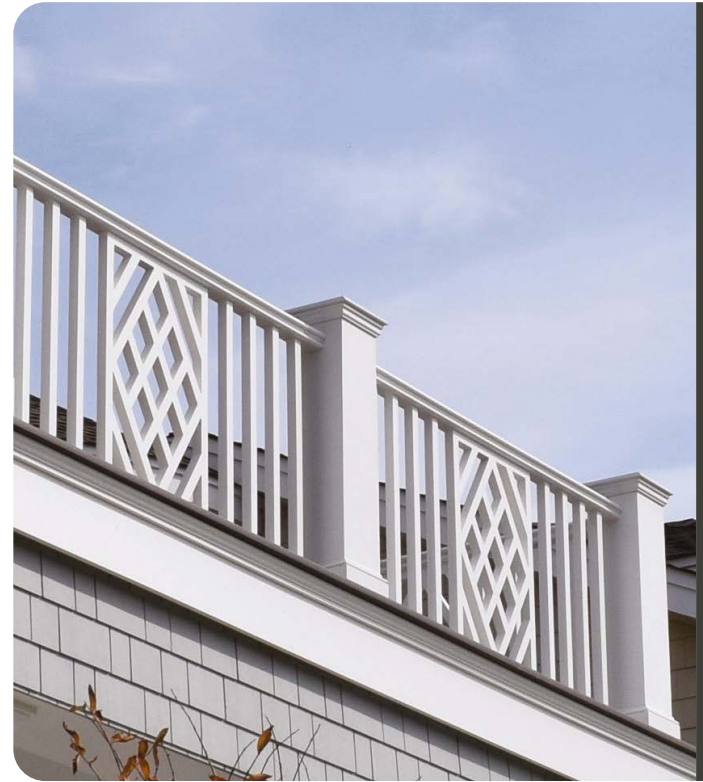



**Narrow Decorative Panel Standard Styles**

		
STONE HARBOR	VENTNOR	WILDWOOD

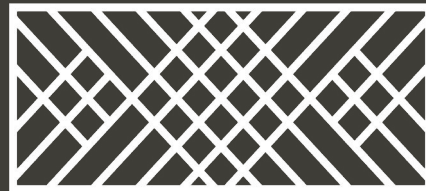

**Full Infill Decorative Panel Standard Styles**

	
7 MILE ISLAND	REFLECTING
	
TYPE 3L	

**Square Decorative Panels**

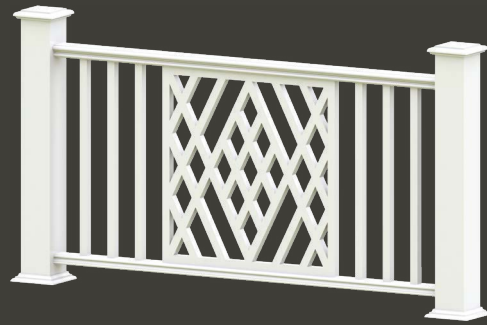

AVALON



DIAMOND WEB

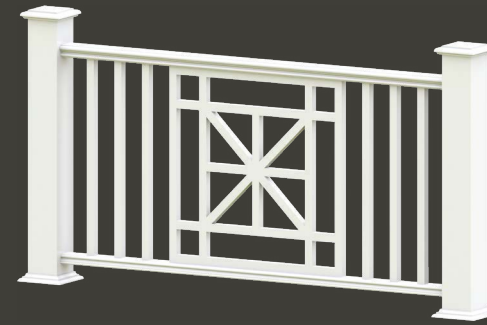

PRAIRIE

**Narrow Decorative Panels**

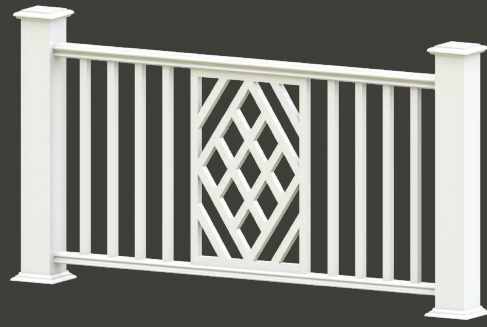

STONE HARBOR



VENTNOR

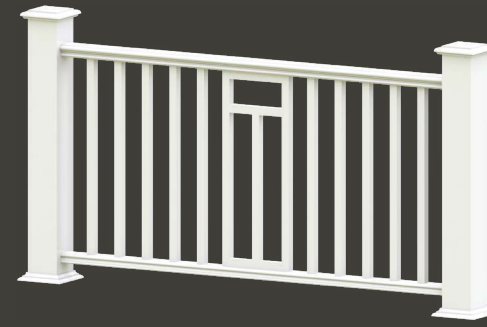

WILDWOOD

**Double Decorative Panels**

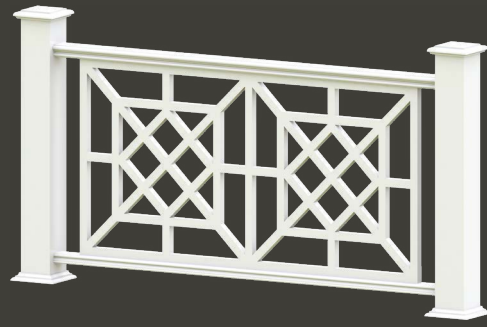

DOUBLE DIAMOND WEB

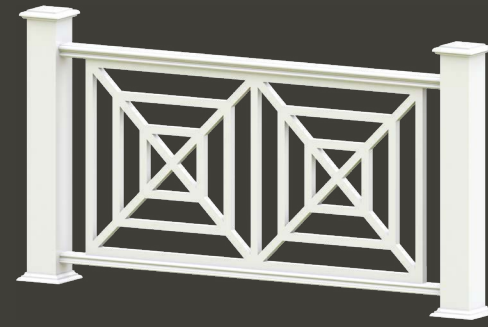

DOUBLE SQUARE WEB

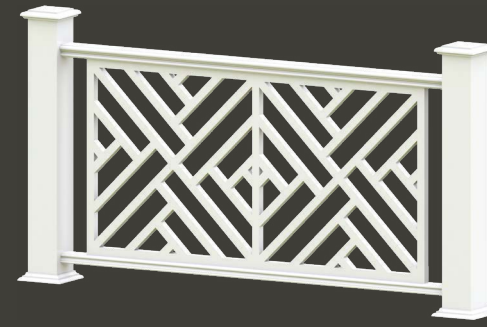

DOUBLE TYPE 1

**Full Infill Decorative Panels**

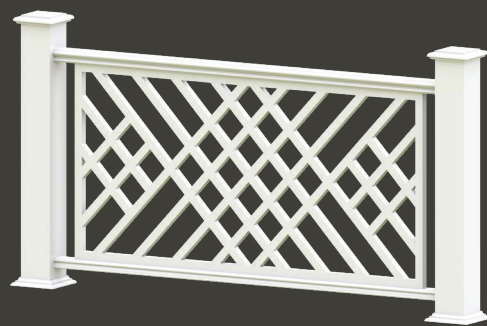

7 MILE ISLAND

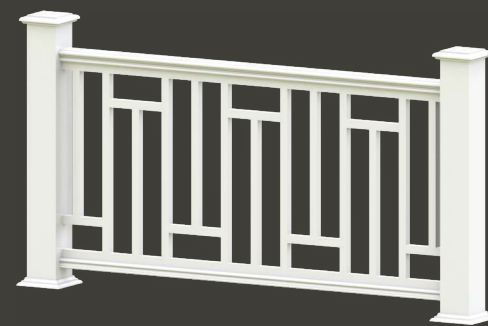

REFLECTING

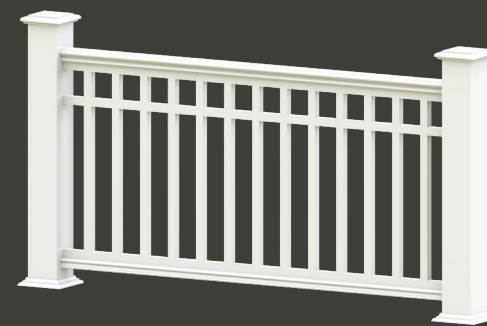

TYPE 3L

# Custom Decorative Panels RAIL UPGRADES

Take Your Railing Project to the Next Level with Fully Customized Decorative Panels!

**CUSTOM DECORATIVE PANELS**

- Choose from our library of custom panels, or create your own
- Available as a Square, Narrow, Double or Full Infill panel in your custom design
- Available for level, stair and radius rail applications
- Custom Decorative Panels for TimberTech Statement Rail and Pinnacle Rail come pre-finished and do not require paint, but can be painted with a light reflective value (LRV) of 55 or greater



Scan to see our library of Custom Decorative Panel Examples!



**FROM CONCEPT TO REALITY!**

INTEX's custom Deco Panel capabilities allow you to customize your rail infill design at an affordable price-point in a short lead-time. Pricing for custom Deco Panels is simply based on thickness, width, and height, so the design flexibility is limitless!

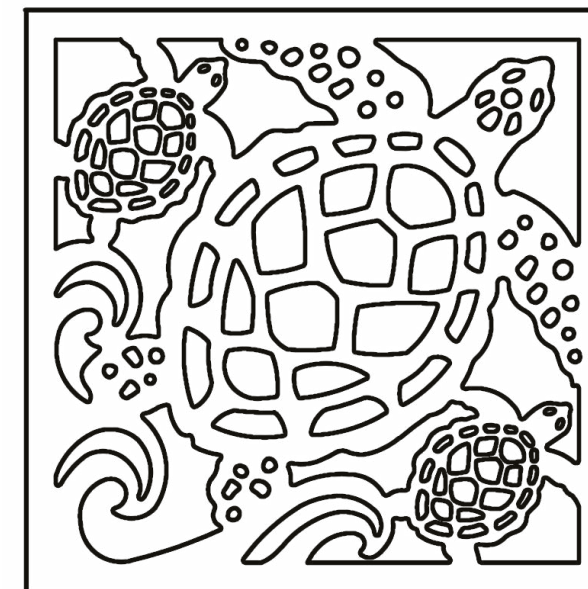

# Glass Balusters

## RAIL UPGRADES

Whether it's your waterfront destination, or your countryside escape – INTEX railing with glass balusters combine the beauty and sight lines of an unobstructed view, with the safety of traditional, vertical rail infill.

- Available in 6ft & 8ft lengths, for level rail only
- Not available for stair rail
- Available for 36" & 42" level rail
- No mechanical fastening or field routing
- Tempered glass balusters (1/4" x 3-5/8") come in packs of 5
- Top & bottom rails are routed for a clean look with easy installation
- Enjoy a beautiful, unobstructed view that also lets in a cool breeze!

	Glass Baluster Availability
TimberTech Statement Rail	✓
TimberTech Pinnacle Rail	✗

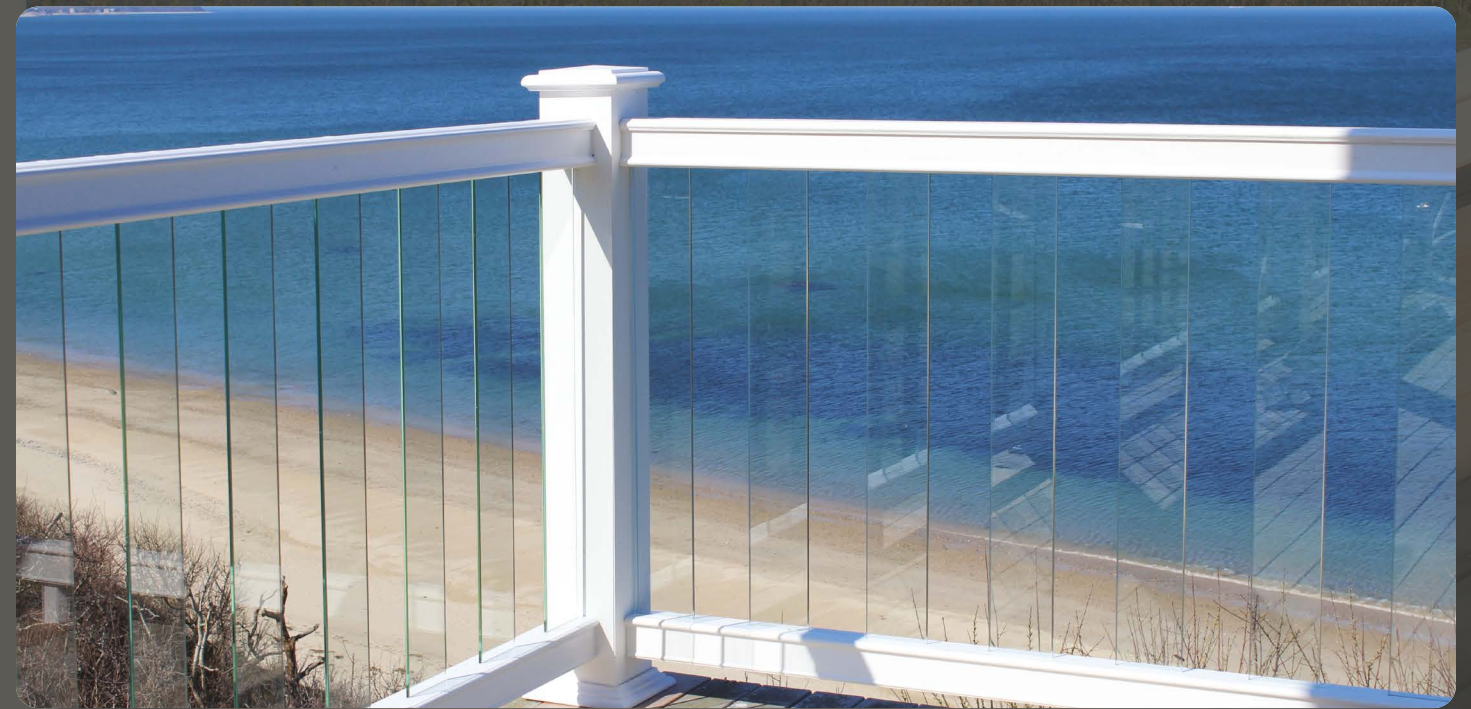

# 3-Line & Mahogany Rail

## RAIL UPGRADES



**Add an Extra Touch of Style and Character to Your Next Rail Project!**

### 3-LINE RAIL KITS

3 Line Rail Kits include: Horizontal Rails, Structural Reinforcements, Square Balusters, Hardware and Crush Blocks.

	Mahogany Cap Availability	3-Line Rail Availability
TimberTech Statement Rail	✗	✗
TimberTech Pinnacle Rail	✓	✓

### FSC CERTIFIED MAHOGANY RAIL CAPS

Adding the timeless detail of a Mahogany Cap will bring your railing project to the next level with the look and feel of real wood! Mahogany Caps come ready for the finish of your choice, and are available in level rail, stair rail and TimberTech Pinnacle Rail radius applications.



# Louver Infill

## RAIL UPGRADES

### Louver Rail Infill

Louver Infill provides fast and easy installation due to routed, vertical stanchions and easily trimmable sizes that create custom fits.

- Greater privacy while maintaining airflow to your deck or porch
- Ships as trimmable kits at 6', 8', and 10' level sections only, for 36" or 42" high rail
- Custom heights also available



	Louver Infill Availability
TimberTech Statement Rail	✗
TimberTech Pinnacle Rail	✓

### Louver Accessories

#### LOUVER GABLE VENTS

- Available as functional or decorative
- Available in custom sizes
- Custom shapes available include triangle, square, round, circle-top, etc.



#### LOUVER PRIVACY WALLS

- Greater privacy while maintaining airflow to your deck or porch
- Ships as a trimmable system made to your desired width and height
- Ideal for built-in outdoor showers, multi-family partitions for privacy, mechanical enclosures



# Horizontal Baluster Infill

## RAIL UPGRADES



### HORIZONTAL BALUSTER INFILL

- Achieve a more contemporary or modern design without the cost, labor, or maintenance of alternative Horizontal Infills
- Ships as trimmable kits at 6', 8', and 10' level sections only, for 36" or 42" high rail
- Fast and easy installation due to pre-routed, vertical stanchions and easily trimmable sizes that create custom fits
- Custom heights also available

	Horizontal Balusters Availability
TimberTech Statement Rail	✗
TimberTech Pinnacle Rail	✓



# Aluminum-Reinforced Gates

## RAIL UPGRADES

INTEX Gates for TimberTech Statement & Pinnacle Rail Systems are reinforced with aluminum, crafted with no open cells and are available using any of our standard rail profiles. Available as single or double gates at 36" or 42" rail heights. INTEX Gates for TimberTech Statement & Pinnacle Rail Systems cannot be trimmed or cut to size.



**STANDARD GATE FOR TIMBERTECH STATEMENT RAIL** 💰💰💰💰



**STANDARD GATE FOR TIMBERTECH PINNACLE RAIL** 💰💰💰💰



**CUSTOM INFILL GATES** 💰💰💰💰  
Available for TimberTech Statement & Pinnacle Rails



**CUSTOM INFILL GATE EXAMPLE**

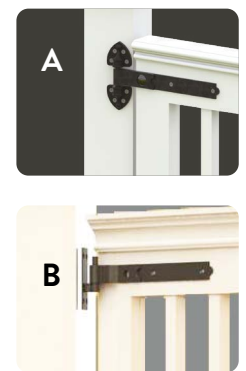

**GATE HARDWARE**

INTEX Rail Gate Mounting Hardware set includes Two 12" Band Hinges, Latch & Stop, all in black.

A. Face-Mount Hardware Application  
B. In-Line Hardware Application

# Transition Kits

## RAIL UPGRADES

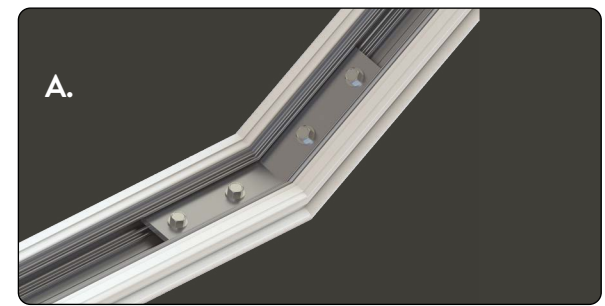

**A. IN-LINE RAIL ELEVATION CHANGE, ADJUSTABLE (NOT AT A NEWEL)**  
Adjustable by bending to the required angle, and will change the rail direction up or down.

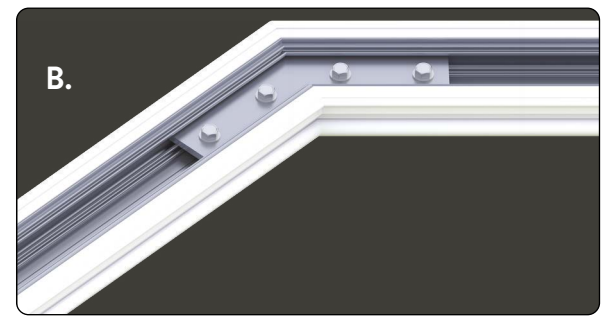

**B. LEVEL RAIL DIRECTION CHANGE 45° OR 90° (NOT AT A NEWEL)**  
Used to change rail direction within the span, while leaving the connections to the newel(s) flush.

	Transition Kits Availability
TimberTech Statement Rail	✓
TimberTech Pinnacle Rail	✓

# How to Order COLUMN WRAPS

## STEP 1

### Select Structural Post (By Others) To Be Covered

*INTEX Column Wraps Are Non-Structural*

- Pressure Treated 4x4  
Works With All INTEX Columns
- Pressure Treated 6x6  
Does Not Fit 6" Column
- Pressure Treated 8x8  
Does Not Fit 6" or 8" Column

## STEP 2

### Select the Proper Width

*Custom Column Widths Also Available, See Next Page for Details*

- 8" Column  
Does Not Fit Over PT 8x8
- 10" Column
- 12" Column
- Custom Width up to 24"

## STEP 3

### Select the Proper Height

*Custom Column Heights Also Available, See Next Page for Details*

- 8' Column
- 9' Column
- 10' Column
- 12' Column
- Custom Height up to 18'

## STEP 4

### Select the Panel Detail

- Plain Flush Panel
- Recessed Panel
- Recessed Panel with Inlay
- Raised Panel
- Chamfered

## STEP 5

### Select the Panel Orientations

- Panel 4 Side
- Split Panel 4 Side
- Line, Corner, End

## STEP 6

### Select Cap & Base Style

- Style H Standard (Included)
- Style A
- Style B 164 BC
- Style C 75 BED
- Style D 163 CROWN
- Style E 49 CROWN
- Style F WM97 CASING

### Cap & Base Styles

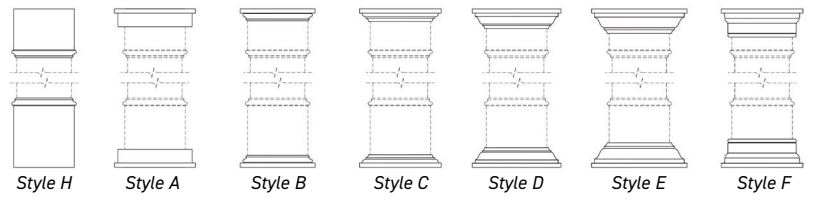

# Panel Styles COLUMN WRAPS

Column Wraps are shipped in two halves and ready to be incorporated with structural components – typically a Pressure Treated 4 x 4, 6 x 6, or 8 x 8 – for installation.

### CHAMFERED

### RECESSED PANEL

### RECESSED SPLIT PANEL

### RECESSED PANEL WITH INLAY

### RECESSED PANEL WITH INLAY SPLIT

### RAISED PANEL

### RAISED PANEL SPLIT

### PARAMETRIC ORDERING: CUSTOM COLUMN SIZES

If a standard Column Wrap width or height doesn't work for your application, simply chose a Column Panel Style and measure & supply the width and height (as noted, right) to our team!

## COLUMN WRAPS

- Standard Widths: 8", 10", & 12"
- Standard Heights: 8', 9', 10', & 12'
- Custom Widths & Heights Also Available

Column Size	Raised or Chamfered	Recessed or Recessed with Inlay
8"	6-3/4"	6" at Center, 6-3/4" at Top & Bottom
10"	8-3/4"	8" at Center, 8-3/4" at Top & Bottom
12"	10-3/4"	10" at Center, 10-3/4" at Top & Bottom



GET AN INSTANT QUOTE!  
www.intexbyazek.com

	Chamfered	Recessed	Recessed with Inlay	Raised
Line, Corner, or End Configuration	✗	✓	✓	✓



# Common Features NEWEL WRAPS

Wrapped in stylish designs, newels and columns can do double duty as both vital architectural components and dramatic visual elements. Homes adorned with columns and newels convey a feeling of timeless strength and beauty.

### ALL INTEX NEWEL WRAPS:

- 100% Cellular PVC
- Multiple style options available – Flat, Recessed, Raised, or Chamfered
- Compatible with TimberTech Statement & Pinnacle Rails
- Custom Newel Wraps can be created to meet your design requirements or for historic restoration
- Do not require paint, but can be painted with a light reflective value (LRV) of 55 or greater



## How to Order MILLWORK NEWEL WRAPS

### STEP 1

Select a Structural Post (By Others) To Be Covered

- TimberTech Secure Mount Post
- Pressure Treated 4x4
- Pressure Treated 6x6

### STEP 2

Select the Proper Width

- 6" (does not fit PT 6x6)
- 8"
- 10"
- 12"

*Custom Sizes Also Available, See Next Page for Details*

### STEP 3

Select the Proper Height

- 40" (for 36" level rail)
- 46" (for 42" level rail)
- 50" (for bottom of stair)

*Custom Heights Also Available, See Next Page for Details*

### STEP 4

Select a Panel Detail

- Flush
- Recessed
- Recessed with Inlay
- Raised
- Chamfered

*See Page 18 For Panel Details*

### STEP 5

Select the Panel Orientations

- Panel 4 Side
- Line
- Corner
- End

*See Drawings On Previous Page For More Information*

### STEP 6

Select the Cap Style & Size

- Skirted Caps (For Panel 4 Side)**
  - NTC-S40 2 Tier Flat Cap with Skirt
  - NPTC-S40 Pyramid Cap with Skirt
- Non-Skirted Caps (For Line Corner End)**
  - NTC 2 Tier Flat Cap
  - NPTC Pyramid Cap

*For More Newel Cap Styles See Page 19*

### Short Panel 4-Sides vs Line, Corner, and End Newels

- Short Panel 4-Side Newels are predominantly designed for Skirted Newel Caps (top rail dies into skirt, not newel face)
- Short Panel 4-Side can be used when the supplier doesn't know newel locations, but it is not recommended (inferior detail)
- Skirted Newel Caps cannot be used with Line, Corner, and End Newels
- Line, Corner, and End Newels are designed to give a full panel detail on non-rail side and flush panel face on rail side

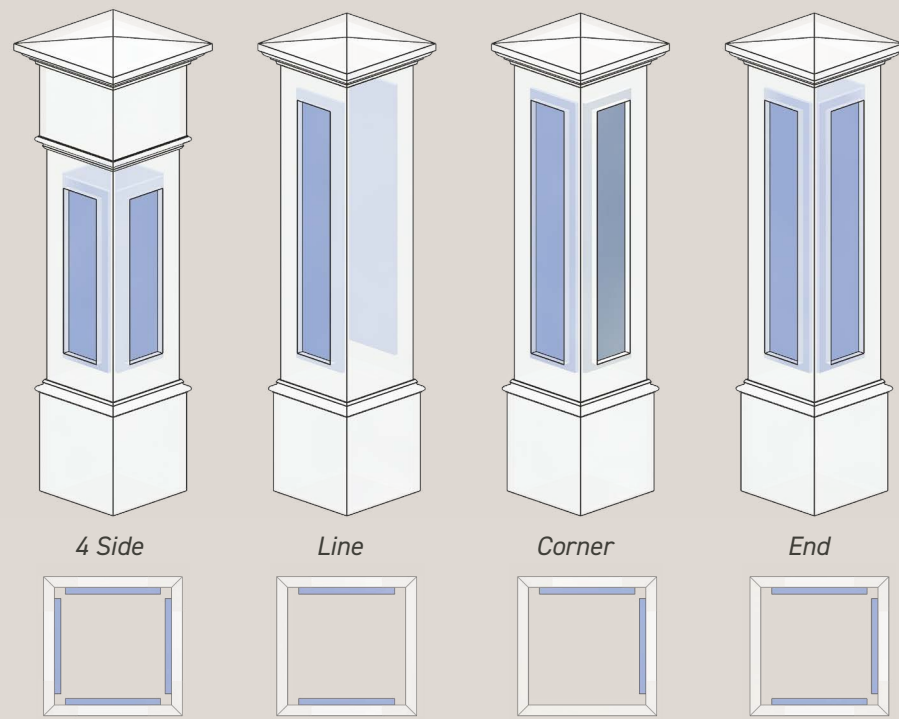

# Panel Styles

## NEWEL WRAPS

Millwork Newel Wraps are shipped fully assembled and ready to be incorporated with structural components – typically a 4 x 4, 6 x 6, or a Structural Post Mount – for installation.

**BEFORE ORDERING, PLEASE NOTE:**

- 40" Newels are for use with 36" level rails
- 46" Newels are for use with 42" level rails
- 50" Newels are for use at the bottom of stairs

**INSIDE CLEARANCE**

Newel Size	5/8" Raised, or Chamfered	Recessed or Recessed with Inlay
6"	4-3/4"	4" at Center, 4-3/4" at Top & Bottom
8"	6-3/4"	6" at Center, 6-3/4" at Top & Bottom
10"	8-3/4"	8" at Center, 8-3/4" at Top & Bottom
12"	10-3/4"	10" at Center, 10-3/4" at Top & Bottom

Actual Footprint Includes Base Wrap

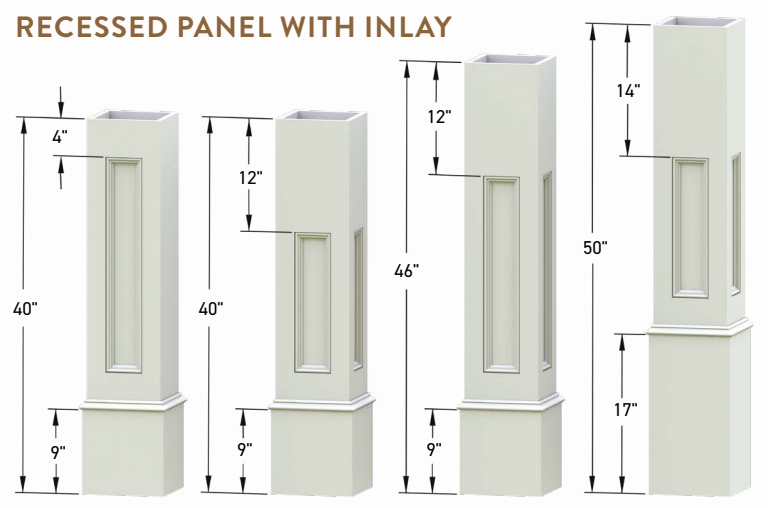
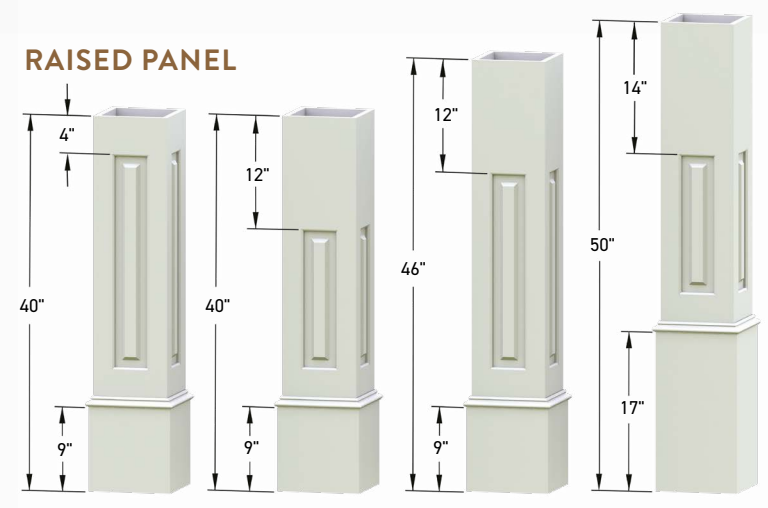
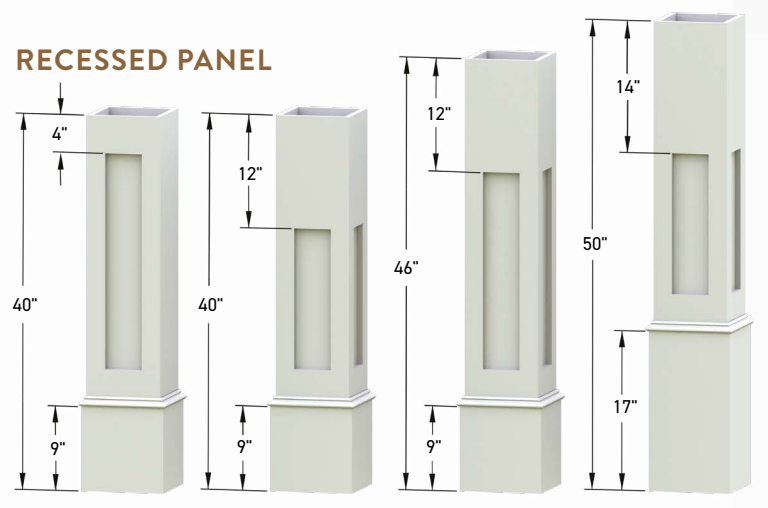
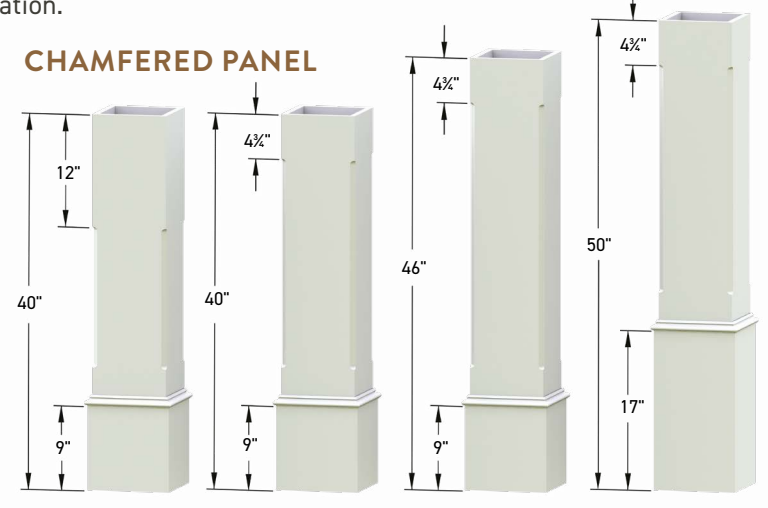

**PARAMETRIC ORDERING: CUSTOM NEWEL SIZES**

If a standard Newel Wrap width or height doesn't work for your application, simply chose a Newel Panel Style and measure & supply the width and height (as noted, right) to our team!

	Chamfered	Recessed	Recessed with Inlay	Raised
Line, Corner, or End Configuration	✗	✓	✓	✓

# Newel Cap Styles

## NEWEL WRAPS

Choose From Our Selection of Standard Newel Caps or Design Your Own!

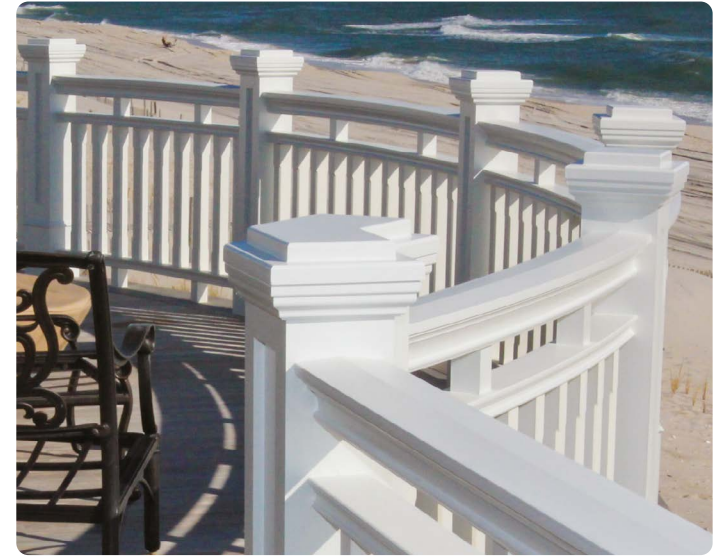

**STANDARD NEWEL CAP STYLES:**

- Flat 2 Tier Cap (NTC)
- Pyramidal Cap WM75 (NPTC)
- 2 Tier Plain Cap With 287 Rake Trim (NTCR)
- Island Cap Pyramidal (NICP)
- 3 Tier Cap WM75 Trim (NTTC)
- Harbor Cap Pyramidal (NHC)
- Harbor Cap Flat (NHCF)
- Triton Cap (NTCT)
- Pyramidal Cap With Skirt For 40" - 46" Newels (NPTC-S40)
- Pyramidal Cap With Skirt For 50" Newels (NPTC-S50)
- 3 Tier Cap With Skirt For 40" - 46" Newels (NTTC-S40)
- 3 Tier Cap With Skirt For 50" Newels (NTTC-S50)

All flat top caps are available with ball finial; add "B" to the end of the product code

- STANDARD NEWEL CAPS**
- All standard Newel Caps are available as 6", 8", 10", and 12"
  - Larger standard and custom sizes are available upon request
  - All flat-top Newel Caps are available with Ball Finial



## Frequently Asked Questions

### CAN INTEX PRODUCTS BE PAINTED?

If you choose to paint your INTEX products, we recommend the use of Exterior 100% Acrylic Latex paint. INTEX products should only be painted colors with an LRV (light reflective value) greater than 55. Please see our installation instructions for more details.

### HOW DO YOU CLEAN CELLULAR PVC?

Cleaning INTEX products is easy and fast with most major household cleaners. For specific recommendations and instructions, visit [intexbyazek.com](http://intexbyazek.com). Harsh cleaners with glycol ethers or ethanol type solvents and/or isopropyl alcohol are not recommended.

### HOW LONG DO INTEX PRODUCTS LAST?

INTEX products are designed to last in the harshest of environments. For this reason, all INTEX products carry a warranty. Please visit [intexbyazek.com](http://intexbyazek.com) for more information.

### WHERE CAN I PURCHASE INTEX PRODUCTS?

Visit [intexbyazek.com](http://intexbyazek.com) to find an authorized dealer near you.



45 Mill Street • Mays Landing, NJ 08330  
(856) 293-4100

[intexbyazek.com](http://intexbyazek.com) | [#intexbyazek](https://twitter.com/intexbyazek)

© 2023, INTEX MILLWORK SOLUTIONS